

CHARACTERISTICS

Nominal Voltage		12V
Nominal Capacity (20 hour rate)		94Ah
Capacity 25°C	10 hour rate (9.0A)	101.0Ah
	5 hour rate (15.9A)	86.0Ah
	1 hour rate (55.4A)	62.5Ah
Internal Resistance		Full Charged Battery 25°C ≤6mΩ
Capacity affected by Temperature (10 hour)	40°C	102%
	25°C	100%
	0°C	85%
	-15°C	65%
Self-Discharge 25°C Capacity	after 3 month storage	90%
	after 6 month storage	80%
	after 12 month storage	62%
Charge (Constant Voltage) 25°C	Float	Initial Charging Current Less than 23A Voltage 13.6-13.8V
	Cycle	Initial Charging Current Less than 23A Voltage 14.4-14.9V

PACKAGING

Battery Dimensions	Length	307mm
	Width	167mm
	Height	211mm
	Total Height	215mm
Quantity Per Box	1 PC per box	
Net weight Per Box	27.5kg	
Gross Weight	28.0kg	

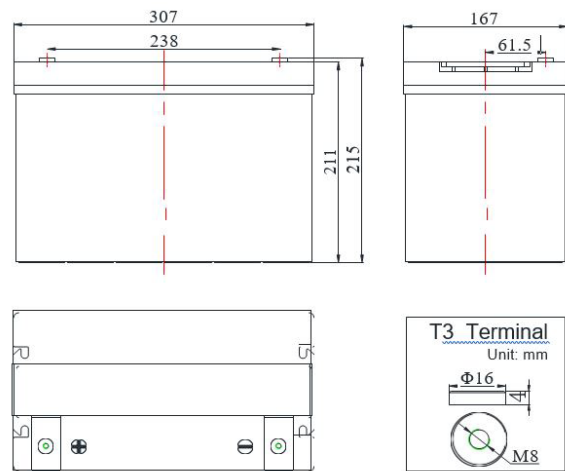

Discharge Constant Current per Cell (Amperes at 25°C)

F.V/Time	30min	1h	2h	5h	10h	20h
1.60V	98.8	62.5	38.1	18.0	9.78	5.25
1.65V	96.1	60.8	37.4	17.7	9.68	5.21
1.70V	93.4	59.2	36.8	17.4	9.59	5.15
1.75V	90.8	57.5	35.8	17.2	9.49	5.10
1.80V	88.2	55.8	35.0	16.9	9.40	5.05

PERFORMANCE CHARACTERISTICS

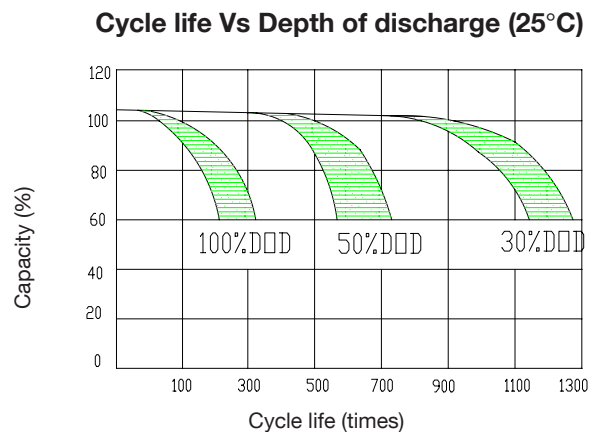
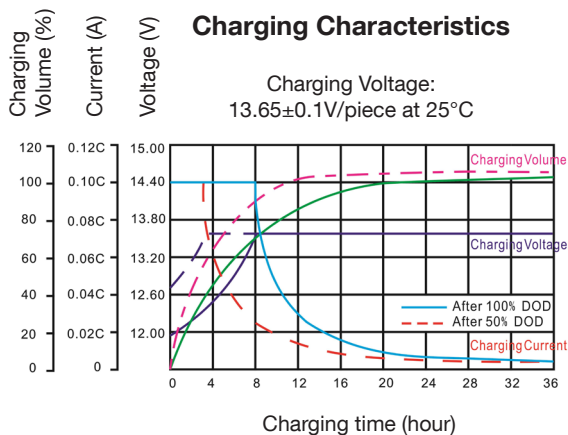

Temperature effect on designed float life

Float charging Voltage:
13.65±0.01V/piece at 25°C

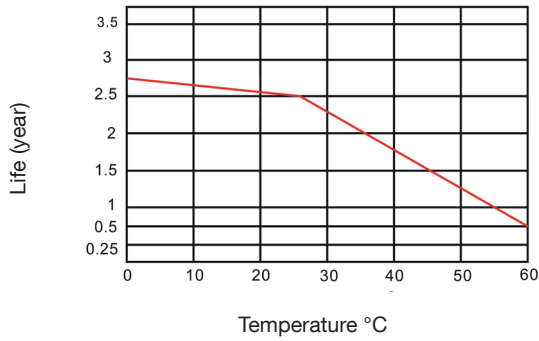

Discharge characteristics (25°C)

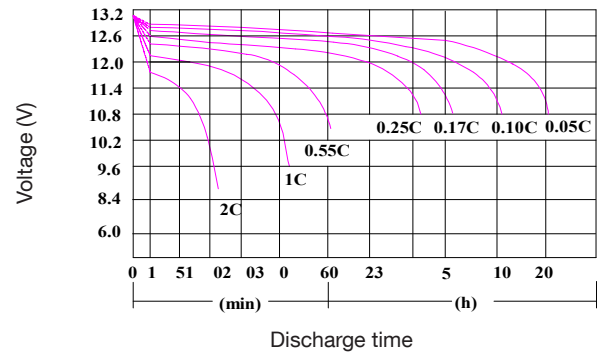

Temperature effect on battery self-discharge

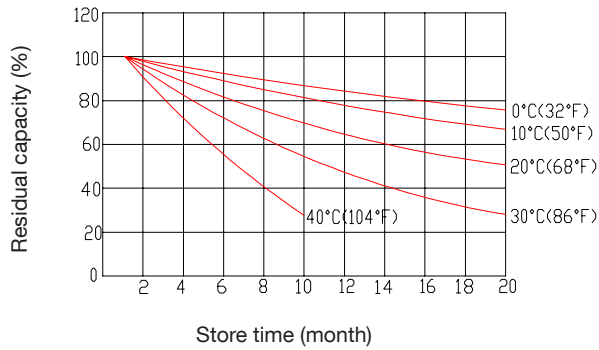

Temperature effect on capacity

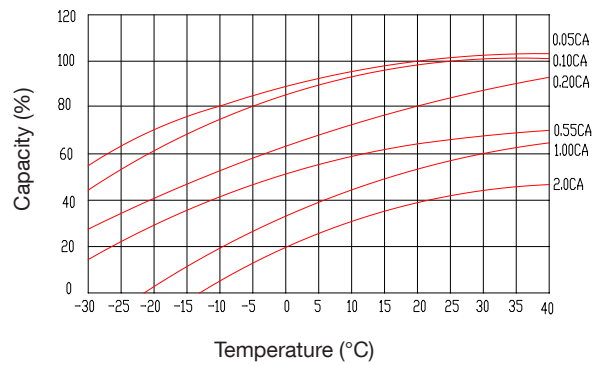

BATTERY CONSTRUCTION								
Component	Positive plate	Negative plate	Container	Cover	Safety valve	Terminal	Separator	Electrolyte
Raw material	Lead dioxide	Lead	ABS	ABS	Si-Rubber	Copper	Fiberglass	Sulfuric acid