

Technical Information

The Predator ES series are an Absorbent Glass Mat (AGM) battery designed for general purpose & standby applications including UPS, communication & security systems. Their ActivFire certification makes them an excellent choice for fire panel applications.

The valve regulated, non-spillable design delivers outstanding cycle life and a low self discharge rate. The Predator ES series are manufactured in a facility which is ISO 9001, 14001 & 45001 certified.

For deep cycle applications, the Predator ED series are recommended.

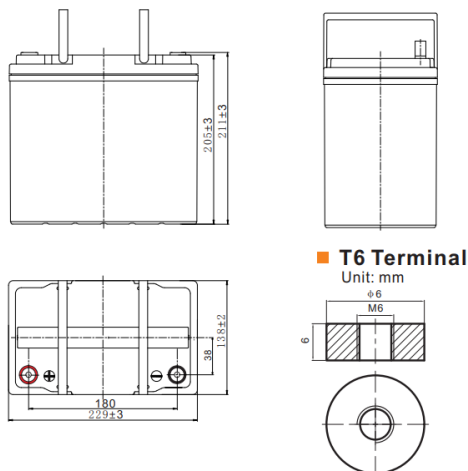

Features & Benefits



- ActivFire Certified
- Heavy Duty, Non-Spillable Design
- Glass Mat Separator Construction
- High Energy Density
- Low Self Discharge
- 5 years design life (@25°C)

Float Service Life @ 25°C

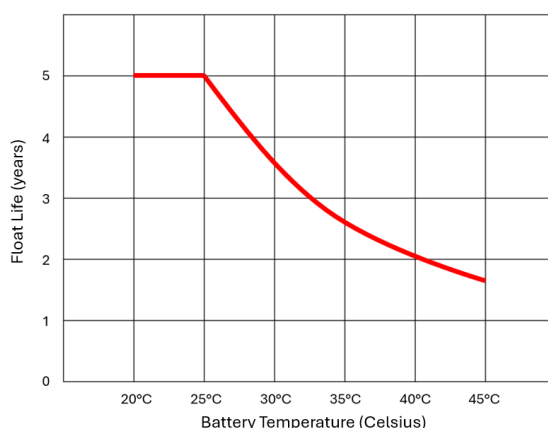

Technical Specifications

Battery Type	General Purpose AGM	Case Material	ABS
Voltage	12V	Case Colour	Blue Case, White Lid
Capacity (20 / 10 / 5Hr)	55 / 51.2 / 47.3Ah	Charge Current	Recommended: 5.5A Maximum: 13.75A
Internal Resistance (25°C)	Approx. 9mΩ	Charge Voltage	14.1 – 14.4V @25°C (Temp. Coeff. -30mV/°C)
Overall Size (LxWxH ±2mm)	229 x 138 x 211mm	Float Voltage	13.5 – 13.8V @25°C (Temp. Coeff. -20mV/°C)
Nominal Weight	16.2kg	Operating Temp. Charge	0 to 40°C
Max Discharge Current (5s)	550A	Operating Temp. Discharge	-15 to 50°C